

WINDOW TO THE NANO WORLD

Cross Section Polisher  
**CP-8000+**



**COXEM**

[www.coxem.com](http://www.coxem.com)

# COXEM CP-8000+ Cross Section Polisher



The CP-8000+ is an advanced sample preparation tool that etches a cross section of a sample using an argon ion beam. This process avoids physical deformation and structural damage, without requiring complicated chemical processes. In addition, the system simplifies cross-sectional analysis of the sample by processing large areas from tens of  $\mu\text{m}$  to several mm.

## FEATURES

- A high etching rate of 700  $\mu\text{m}$  per hour (based on Si, 8 kV)
- Ability to save/load recipes that are frequently used
- Step by step recipes with automatic execution function
- Easy to load sample using smart sample holder
- Real-time observation of ion beam status and etching status (chamber camera)
- Convenient operation - intuitive GUI and easy touch screen
- Minimizes thermal damage with the ion beam Auto On/Off function
- Fast and convenient sample alignment with ion beam using built-in digital microscope
- Provided with noise, vibration, oil-free diaphragm pump
- Flat milling function provided flat milling function for plane etching of a large areas.

## PRINCIPLES OF CROSS SECTION POLISHER

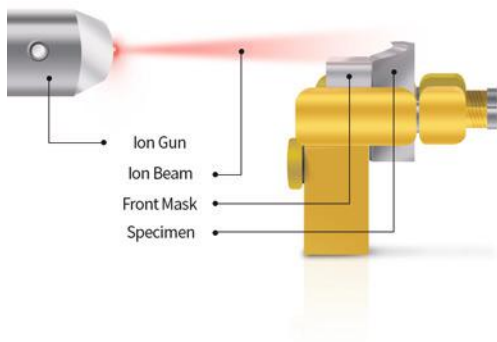

When a voltage is applied to the ion gun and argon gas is injected, plasma is generated and an ion beam is directed at the sample by an acceleration voltage to begin the etching process.

If the sample is located behind a metal mask and the ion beam is directed at the metal mask and sample, the shielding effect of the metal mask minimizes beam damage to obtain clean cross-sectional etching results.

## MECHANICAL POLISHING vs CP POLISHING

If you polish using a mechanical polishing device, it is difficult to check the exact state of the cross section due to physical damage and contamination, but when performing cross-section processing with CP using an ion beam, you can observe the micro-surface structure of the sample without structural damage and contamination.



Mechanical Polishing Only

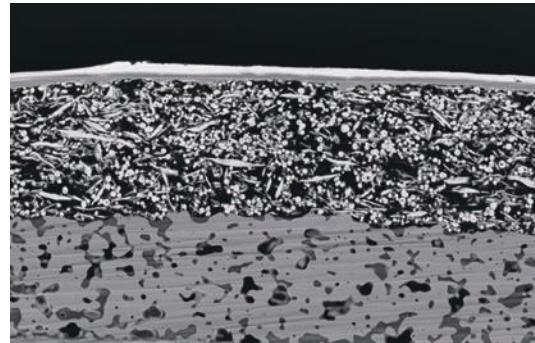

CP Polishing

## FIB POLISHING vs CP POLISHING

When etching a single side of the same sample with the CP-8000+, you can achieve excellent time and cost savings by etching a much wider cross section in a shorter time, compared to focused ion beam (FIB).

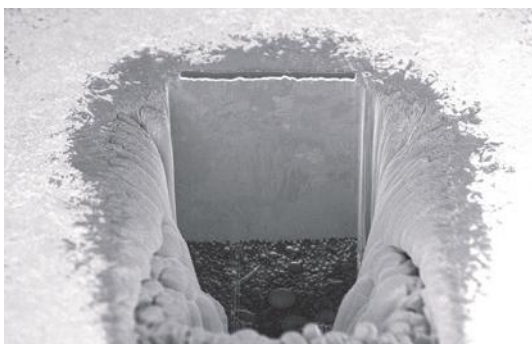

FIB Polishing

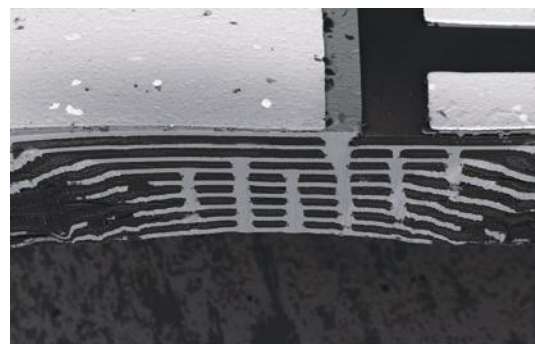

CP Polishing

## CP PROCESS

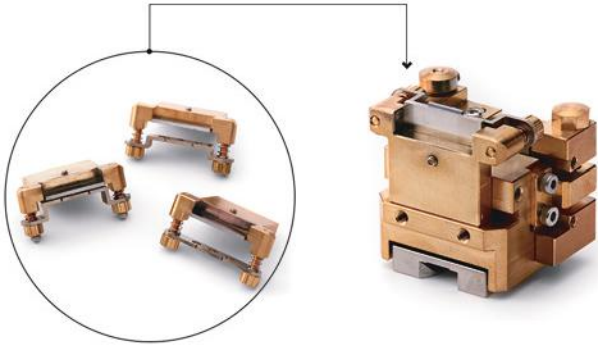

**1.** Select a holder that fits the size of the sample and mount it on the sample stand.

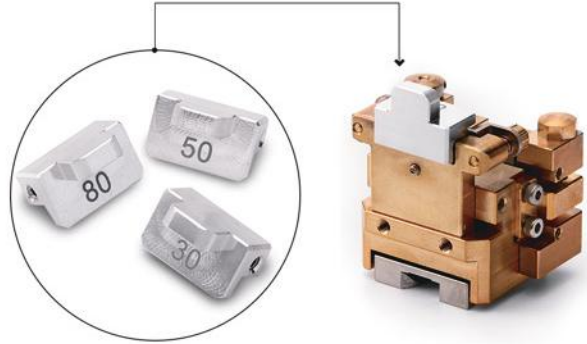

**2.** Adjust the height of the sample by selecting the sample height jig. (Provide with 30, 50, 80  $\mu\text{m}$  jig)



**3.** Fix the sample stand to the digital microscope.

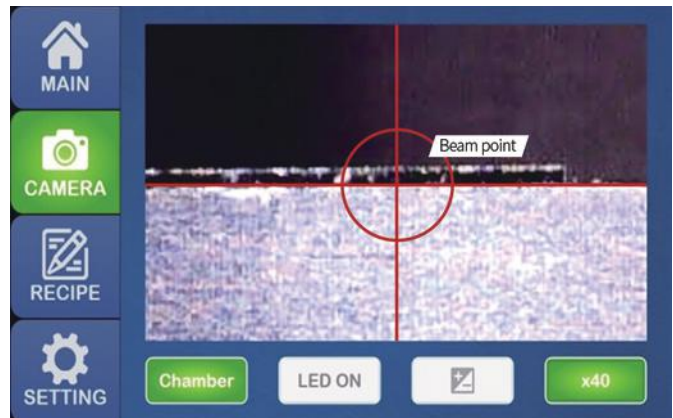

**4.** Select Sample Camera on the screen and place the desired etching position in the middle of the cross line.

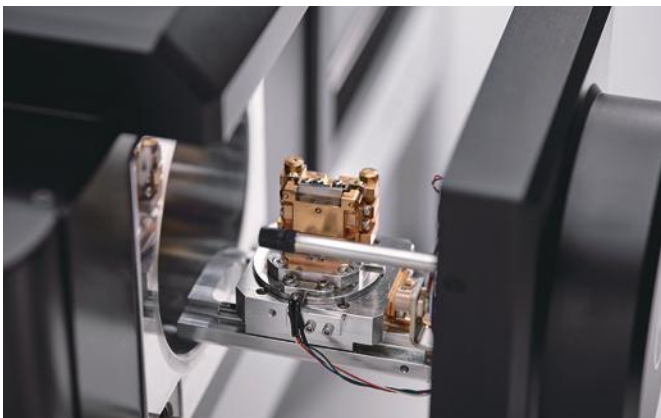

**5.** Open the chamber door and mount the sample stand on the stage.

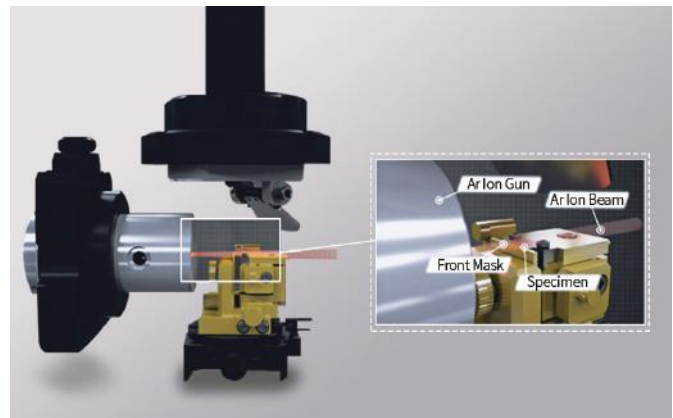

**6.** After entering the desired settings on the screen, press Start to begin etching.

## INTUITIVE GUI



① **Camera**  
: Digital Microscope / Chamber Camera

② **Auto Beam On/Off Mode**

③ **Step-by-step Mode**

④ **Flat Milling Mode**

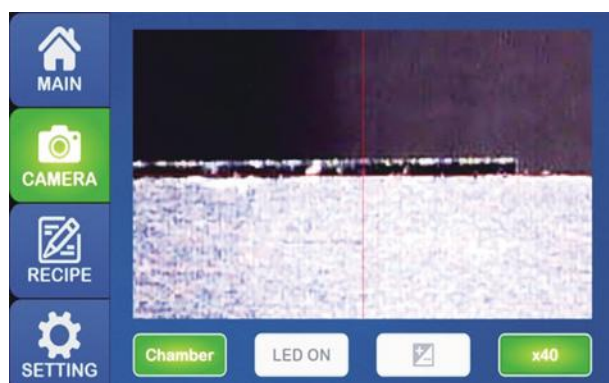

### DIGITAL MICROSCOPE

Using a digital microscope, the position of the ion beam and the position of the sample can be easily aligned through the screen.

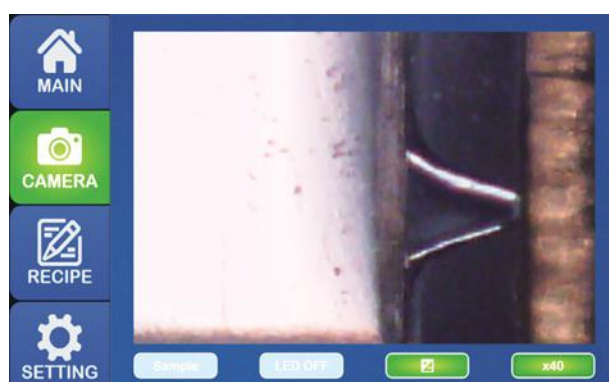

### CHAMBER CAMERA

You can check the status of the ion beam through the camera inside the chamber and check the degree of cross-sectional etching in real time.

## AUTO BEAM ON / OFF MODE

A feature designed to minimize heat damage caused by the ion beam by turning the beam on and off according to the set Ion Beam On/Off timer. It is useful for obtaining accurate cross-sectional conditions when etching heat-sensitive samples such as polymers and paper.

Paper »

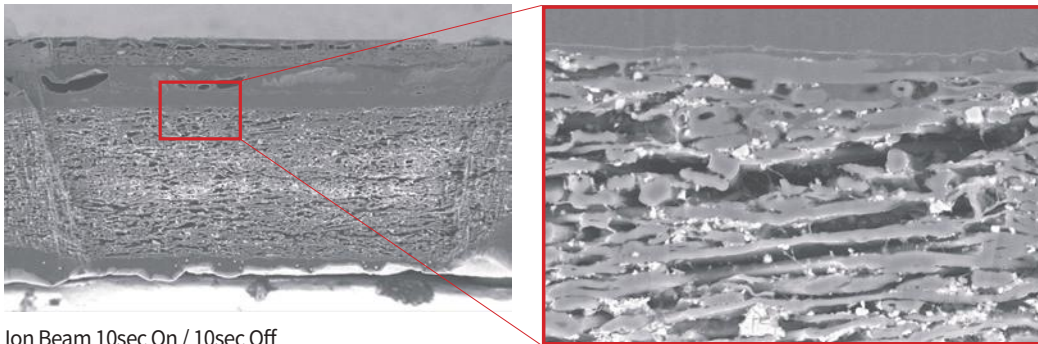

## RECIPE MODE

Frequently used etching conditions can be stored in the recipe list to easily apply setting values whenever necessary. In addition, a step-by-step mode is also available to store several recipes and automatically execute them to etch samples.



**Before using STEP BY STEP MODE**  
(5kV 1hour)



**After using STEP BY STEP MODE**  
(5kV 1hour + 3kV 30min)

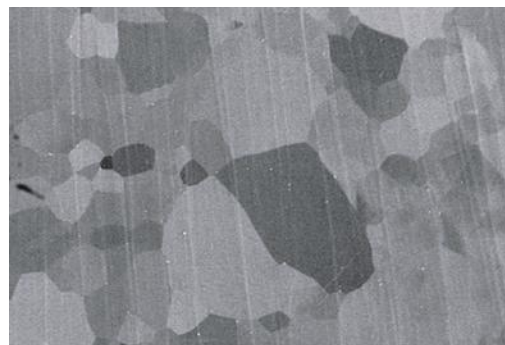

## FLAT MILLING

The CP-8000+ can process samples in a plane using a dedicated holder. When a sample is mounted in the dedicated holder and the flat milling function is used, several mm<sup>2</sup> areas are etched by the ion beam based on the rotation center axis. At this point, since the polishing speed, area, and depth vary depending on the angle of incidence at which the ion beam hits the sample surface, uniform surface polishing should be induced by rotating and adjusting the angle of the sample. As the ion beam irradiates a larger area to etch an oxide layer or foreign substance, it is useful for pre-treatment of a large area of the sample.

MgO »

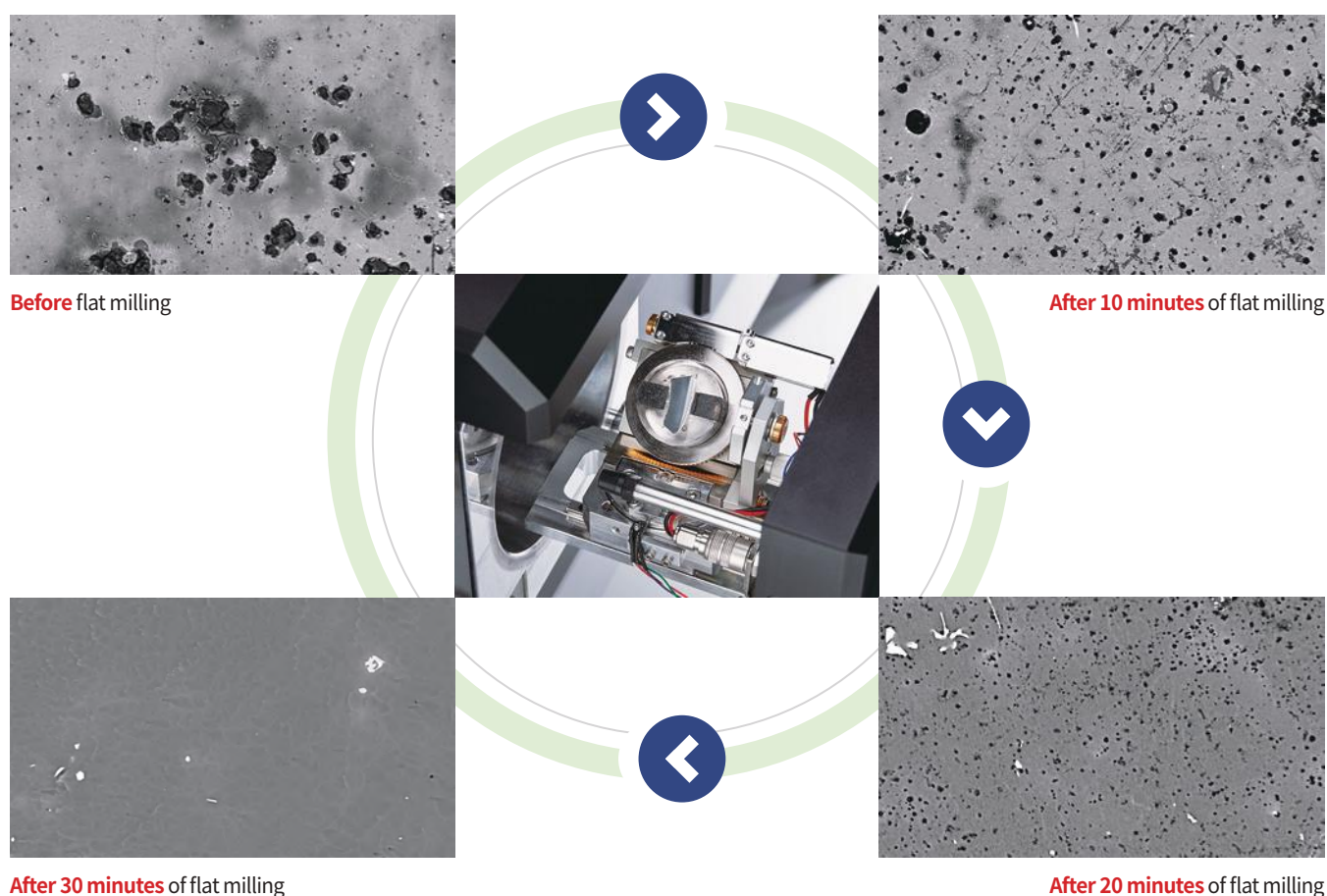

	Before milling	After milling
Element	Weight (%)	
C	12.31	6.27
O	29.44	0.59
Mg	56.42	92.25
Al	1.20	-
Mn	0.10	0.21
Zn	0.54	0.68
Total	100.00	100.00

## CRYSTALLOGRAPHY OF METALLIC MATERIAL

Precise surface pre-treatment is a very important factor for accurate grain and grain boundary analysis of metal samples. Ion beam milling is an ideal method to prepare samples prior to studying the mechanical and electrical properties of the sample through EBSD analysis.

Cu »

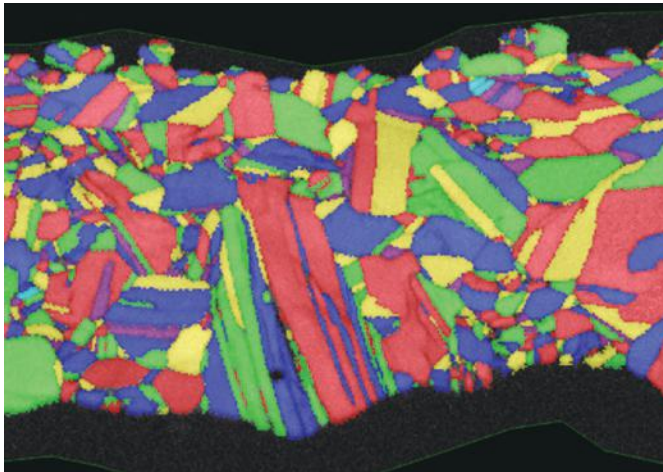

IPF map

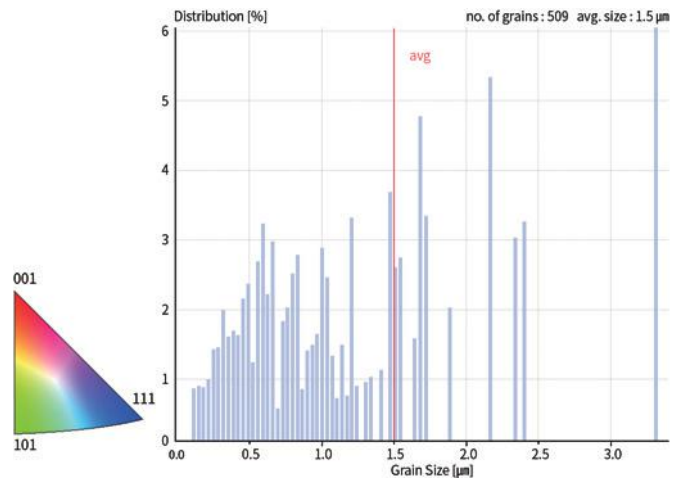

Grain size distribution

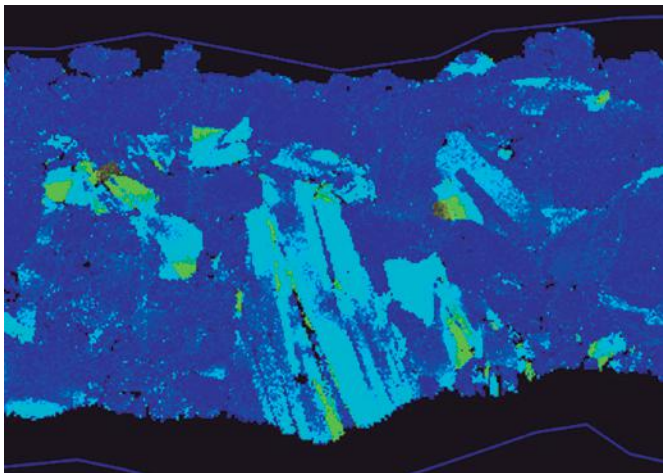

Miss orientation map

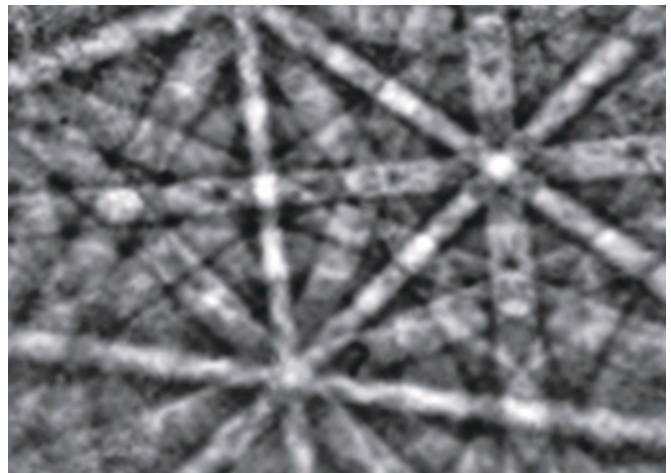

Kikuchi pattern of Copper

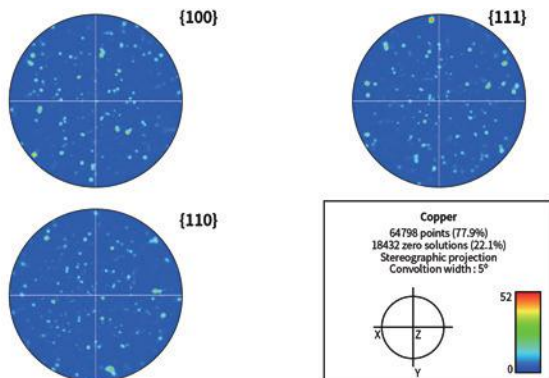

Point group distribution

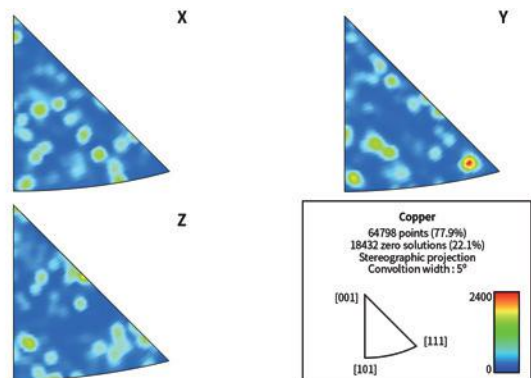

Inverse pole figure



## EPMA ANALYSIS OF CROSS-SECTION OF MINERAL

After removing the oxide layer and foreign substances in the sample cross section through ion milling, EPMA component analysis for more accurate qualitative and quantitative analysis is possible.

The following is a mineral sample, which was etched with CP to remove foreign substances and oxide layers on the surface before analyzing the elemental distribution through EPMA analysis.

### Minerals

»

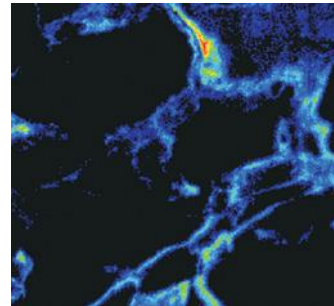
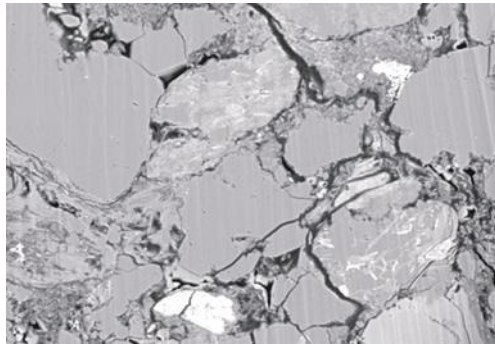

C

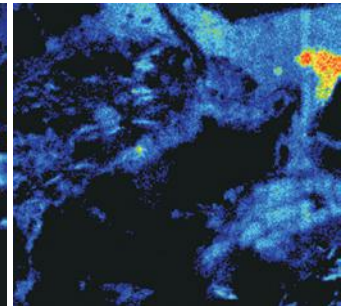

Fe

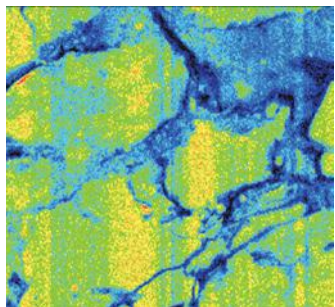

O

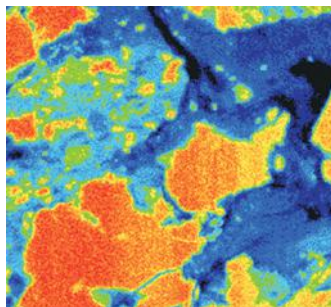

Si

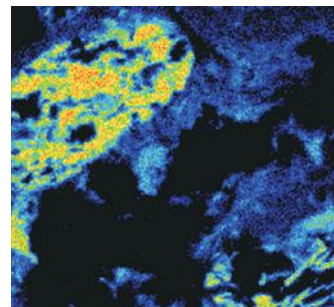

K

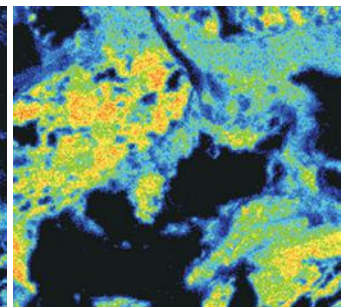

Al

## EDS

By etching a sample with an ion beam to minimize damage to the cross-sectional structure and analyzing the components with EDS, the exact distribution of surface components can be observed without structural distortion of the sample.

MLCC »  
(Multi layer ceramic capacitor)

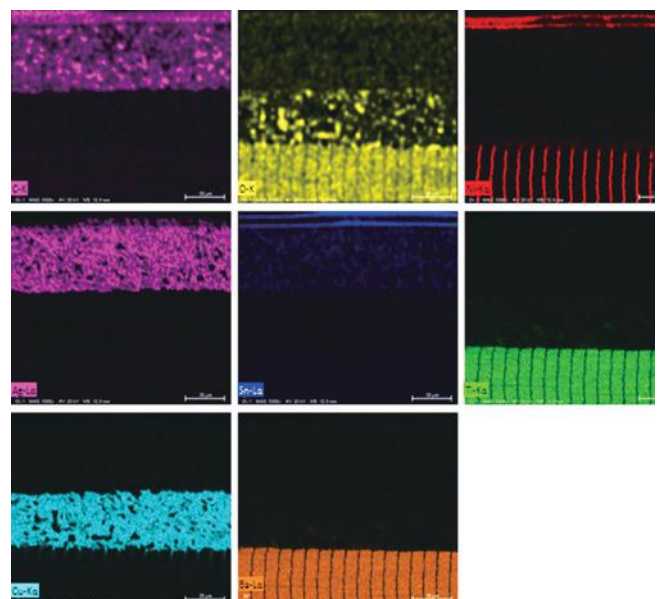
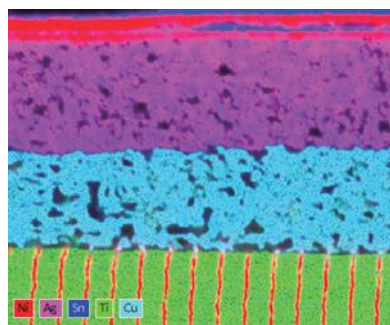

### SEMI-CONDUCTOR

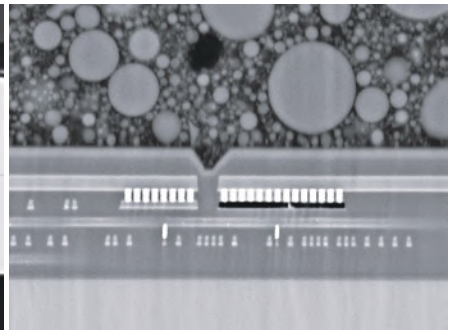
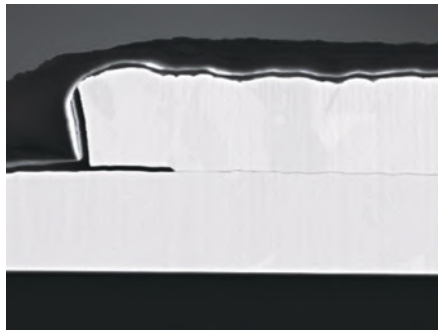
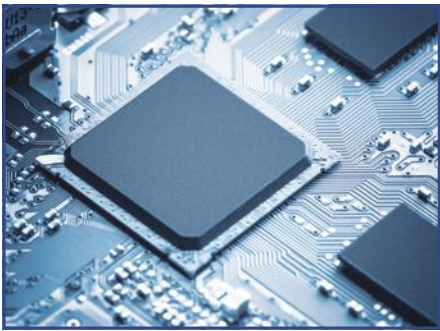

### POWDER

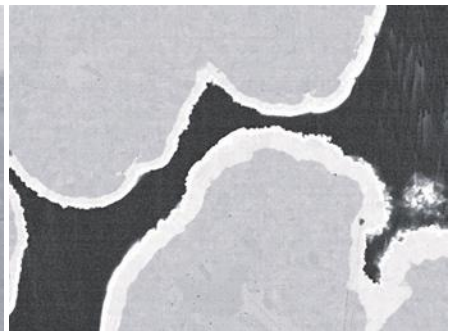
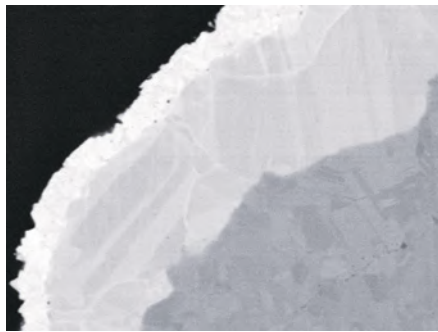

### SOLAR CELL

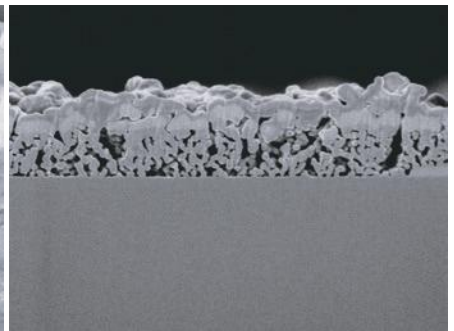
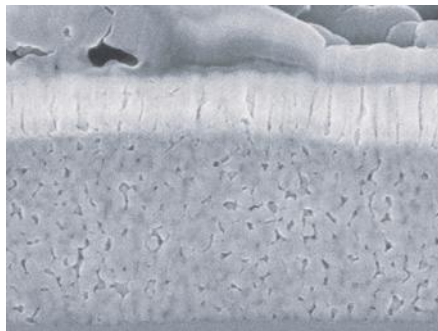

### BATTERY

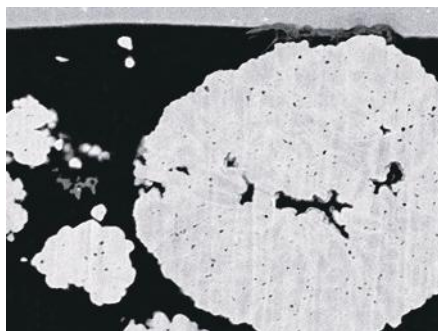

## FIBER

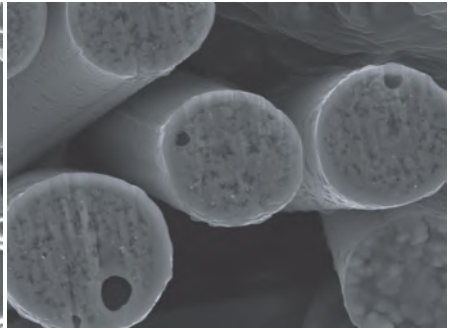
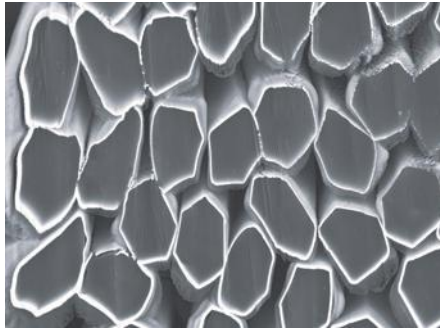

## MINERALS

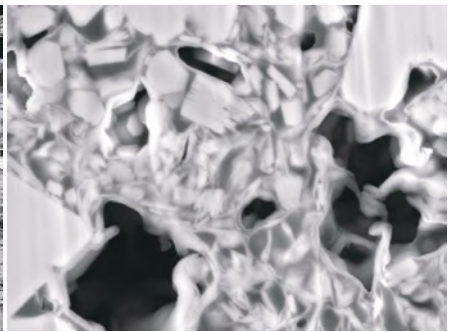

## ALLOYS

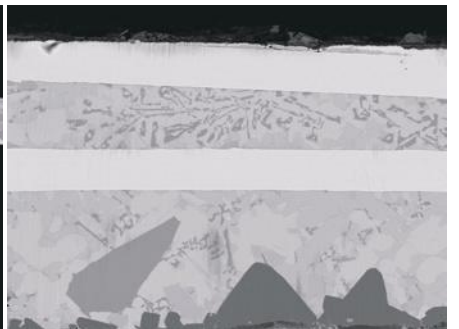

## FILMS



## SPECIFICATIONS

Ion accelerating voltage	2 to 8kV
Milling speed	700 $\mu$ m/h (at 8kV on Si wafer)
Sample stage swing angle	$\pm 35^\circ$
Maximum sample size	20(W) $\times$ 10(L) $\times$ 5.5(T)mm 16(W) $\times$ 10(D) $\times$ 9.5(H)mm
Specimen movement range	X axis movement : $\pm 1.5$ mm / Y axis movement : $\pm 2$ mm
Flat milling stage tilt angle range	40° to 80°
Sample size for flat milling	$\varnothing 30 \times 11.4$ (H)mm
Operation	7 inch touch panel
Digital Microscope for sample positioning	Mag. x5, x10, x20, x40
Chamber camera for monitoring	Mag. x5, x10, x20, x40 Brightness adjustable in 4 steps Ion beam observation mode (LED Off)
Gas for Ion	Argon gas (99.999%)
Gas pressure	0.1 Mpa (14.5psi)
Gas flow control	Mass Flow Control
Vacuum systems	Turbo pump, Diaphragm pump
Dimension	607(W) $\times$ 472(D) $\times$ 277.5(430.5)(H) mm
Weight	Main system 36kg / Diaphragm pump 6.5kg
Features	Auto Beam On/Off mode Step by step mode



**COXEM** Co., Ltd.

#201, 199, Techno2-ro, Yuseong-gu, Daejeon, Republic of Korea (34025)

**TEL.** +82. 42. 861. 1686

**FAX.** +82. 42. 861. 1689

**E-MAIL.** [overseas@coxem.com](mailto:overseas@coxem.com)

**WEB.** [www.coxem.com](http://www.coxem.com)