

PRODUCT DATASHEET

Mini UX

FASTCAM series by Photron



FASTCAM Mini UX50 / UX100

1.3-Megapixel CMOS Sensor:

Mini UX50

1280 x 1024 pixels at 2,000fps

1280 x 800 pixels at 2,500fps

Mini UX100

1280 x 1024 pixels at 4,000fps

1280 x 1000 pixels at 5,000fps

1280 x 800 pixels at 6,250fps

Maximum Frame Rate:

160,000fps (Mini UX50 type 160K)

204,800fps (Mini UX100 type 200K)

800,000fps (Mini UX100 type 800K)

Class Leading Light Sensitivity:

ISO 10,000 monochrome

ISO 5,000 color

Global Electronic Shutter:

Minimum Shutter speed 3.9 μ s (to 1 μ s dependent on frame rate selection)

Dynamic Range (ADC):

12-bit monochrome, 36-bit color

Compact and Lightweight:

120mm (H) x 120mm (W) x 93mm (D)

4.72" (H) x 4.72" (W) x 3.66" (D)

Weight: 1.5Kg (3.13 lbs.)

Internal Recording Memory:

8GB, 16GB, or 32GB

Fast Gigabit Ethernet Interface:

Provides high-speed image download to a standard notebook/PC

Flexible Frame Synchronization:

Frame rate may be synchronized to external unstable frequencies

1-Inch C-mount Compatible Sensor Size:

Also supplied with integrated Nikon G-type lens mounts.

High-G Rated:

Suitable for application in high-G environments; operation tested to 100G, 10ms, 6-axes

COMPACT HIGH-SPEED CAMERA SYSTEM

For use with a wide range of general scientific and industrial applications the Photron FASTCAM Mini UX high-speed camera provides outstanding imaging performance at a very attractive price performance ratio.

Two Mini UX camera models provide 1.3-megapixel (1280 x 1024 pixels) image resolution with frame rates up to 2,000fps from the Mini UX50 and 4,000fps from the Mini UX100. Both models are available with recording memory options up to 32GB providing extended recording times and triggering flexibility.

Using innovative proprietary CMOS image sensor technology, the FASTCAM Mini UX achieves high light sensitivity from a small image sensor (10 μ m pixel pitch) through the utilization of microlenses to increase effective Fill Factor. At maximum image resolution the image sensor is fully compatible with readily available 1-inch C-mount lenses offering a wide choice of small, light weight, rugged and high aperture objective lenses.

The FASTCAM Mini UX features a rugged design suitable for operation in high shock and vibration environments and a compact camera body (120mm x 120mm x 93mm) weighing just 1.5kg. This small and rugged camera design makes the FASTCAM Mini UX ideally suited to on-board and off-board automotive safety testing and many other applications where a compact size and compatibility with standard optical systems is required.

Standard operational features of the FASTCAM Mini UX include a Gigabit Ethernet Interface for reliable system control with high-speed data transfer to PC, and the ability to remotely switch off cooling fans to eliminate vibrations when recording at high magnifications.

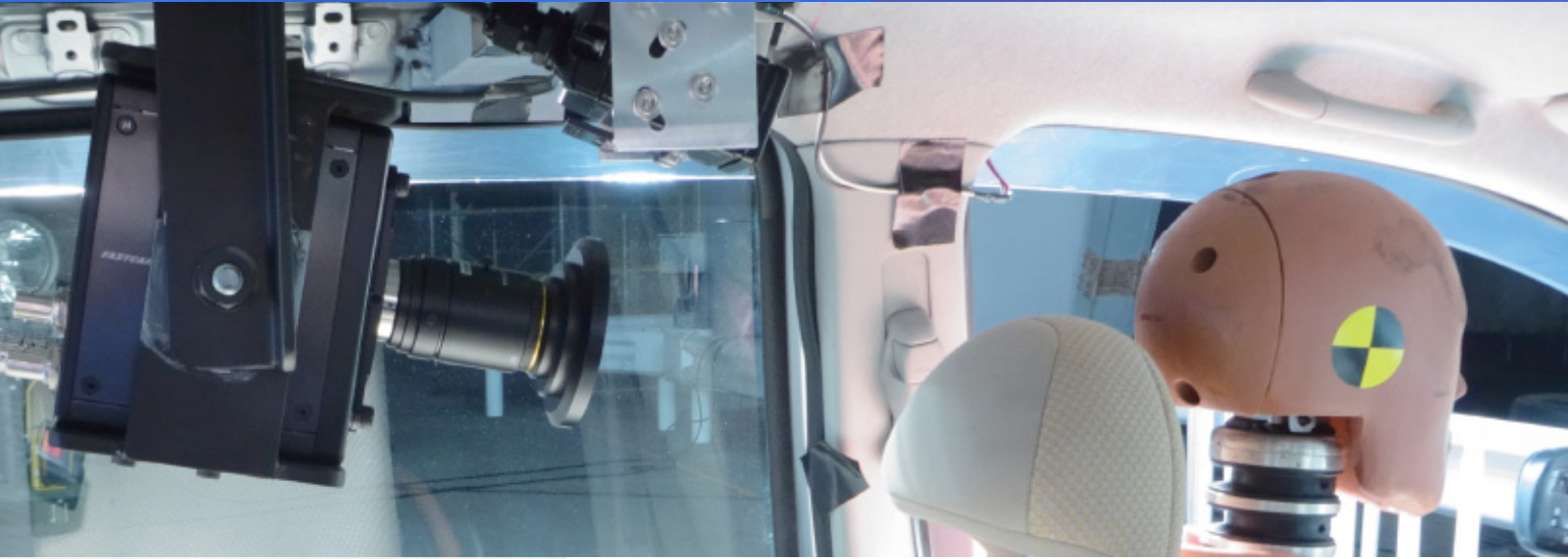

Light Sensitivity:

FASTCAM MINI UX

Monochrome models	ISO 10,000
Color models	ISO 5,000

Monochrome sensors used in the FASTCAM Mini UX cameras are supplied without an IR absorbing filter, extending the camera spectral response beyond 900nm. When the sensitivity of the FASTCAM Mini UX camera is measured to tungsten light including near IR response an equivalent value of ISO 25,000 is obtained.

Image Sensor:

The FASTCAM Mini UX system uses an advanced CMOS image sensor optimized for light sensitivity and high image quality that is unique to Photron.

A 10-micron pixel pitch gives a sensor size at full image resolution of 12.8 x 10.24mm (diagonal 16.39mm).

Lenses designed for both 1-inch C-mount and FX / DX (APS-C digital SLR) formats are compatible with the FASTCAM Mini UX at full image resolution.

Sensor Type	Proprietary Design Advanced CMOS
Maximum Reolution (pixels)	1280 x 1024 pixels
Sensor Size / Diagonal	12.80 (H) x 10.24mm (V) / 16.39mm (D)
Pixel Size (microns)	10µm x 10µm
Quantum Efficiency	62.6% at 630nm
Fill Factor	80%
Color Matrix	Bayer CFA (single sensor)
Light Sensitivity	ISO 10,000 monochrome ISO 5,000 color (monochrome sensor equivalent ISO 25,000 including near IR response)
Shutter	Global Electronic Shutter 3.9µs up to 1.01µs at maximum frame rates

FASTCAM Mini UX Relative Spectral Response Curves - Monochrome and Color

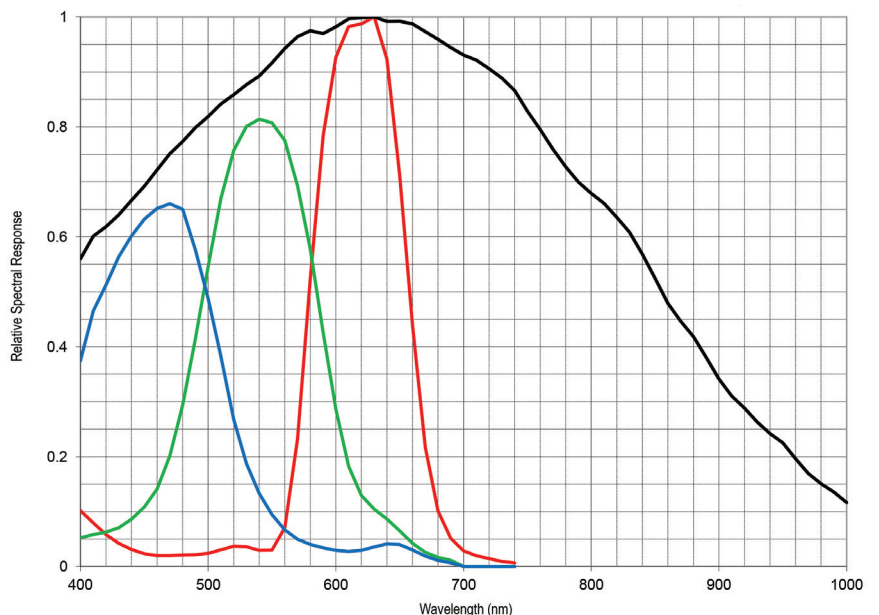

Camera Performance Specifications

Model	Mini UX50	Mini UX100
Full Frame Performance	2,000fps 1280 x 1024 pixels	4,000fps 1280 x 1024 pixels
Maximum Frame Rate	Type 160K: 160,000fps (1280 x 8 pixels)	Type 200K: 200,000fps (640 x 8 pixels) Type 800K: 800,000fps (640 x 8 pixels) *
Minimum Exposure	Global electronic shutter 3.9 μ s (1.01 μ s at maximum frame rates)	
Dynamic Range (ADC)	12-bit monochrome 36-bit color	
Memory Capacity Options	8GB: 4,365 frames at full resolution 16GB: 8,734 frames at full resolution 32GB: 17,472 frames at full resolution	
Memory Partitions	Up to 64 memory segments	
Region of Interest	Selectable in steps of 128 pixels (horizontal) x 8 pixels (vertical) - minimum 640 x 8	
Trigger Inputs	Selectable +/- TTL 5V and switch closure	
Trigger Delay	Programmable on selected input / output triggers: 100ns resolution	
Input / Output	Input: Trigger (TTL/Switch), sync, ready, event, IRIG Output: trigger, sync, ready, rec, exposure	
Trigger Modes	Start, end, center, manual, random	
Time Code Input	IRIG-B	
External Sync	+/- TTL 5Vp-p Variable frequency sync	
Camera Control Interface	High-speed Gigabit Ethernet	
Image Data Display	Frame rate, shutter speed, trigger mode, date/time, status, real time / IRIG time, frame count, resolution	
Saved Image Formats	BMP, TIFF, JPEG, PNG, RAW, RAWW, MRAW, AVI, WMV, FTIF, MOV - Images can be saved with or without image data and in 8-bit, 16-bit or 36-bit depth of sensor where supported	
Supported OS	Microsoft Windows operating system including: XP, Vista, 7, 8, 8.1, 10 (32/64-bit)	

* Frame rates above 225,000fps may be subject to export control regulations in some areas

High-Speed Gigabit Ethernet Interface:

The FASTCAM Mini UX camera system is equipped with a high-speed Gigabit Ethernet Interface to provide reliable network communication and fast download of image data.

Dedicated I/O:

A dedicated BNC connection for a contact closure hardware trigger input is provided. In addition, two programmable inputs and two programmable output channels provide direct connection for common tasks such as synchronization of multiple cameras and operation in conjunction with Data Acquisition (DAQ) hardware.

Nikon G-Type Compatible Lens Fitting:

The FASTCAM Mini UX camera is equipped with an objective lens mount compatible with readily available Nikon G-type lenses. Controls provided within the lens mount allow the control of lens aperture on lenses without external iris control.



Camera Operation Features

Frame Synchronization	Accurate frame synchronization with other cameras and with external and unstable frequencies.
Memory Partitions	Up to 64 memory segments allow multiple events to be stored in camera memory before downloading, with automatic progression to the next available partition.
Low Light Mode	Operation at minimum frame rate with separately adjustable shutter time to allow easy camera set-up and focus in ambient lighting.
IRIG Phase Lock	Enables multiple cameras to be synchronized together with other instrumentation equipment or to a master external time source.
Internal Time Delay Generator	Allows programmable delays to be set on input and output triggers; 100ns resolution.
Event Markers	Up to ten user-entered event markers to define specific events within the recorded image sequence .
Automatic Download	The system can be set to automatically download image data to the control PC and, when download is complete to re-arm in readiness for the next trigger with automatically incremented file names.
Software Binning	Virtual pixel binning (2x2, 4x4 etc.) allows increased light sensitivity with reduced image resolution without changing camera field of view.

Operation Software Features

Image Calibration	2D image calibration allows the measurement of distance and angle from the image. A calibration grid overlay can be superimposed on the image.
Image Overlay	A stored reference image may be overlaid on the live image to allow accurate camera positioning to achieve the same view as a previous test.
Import of Multiple Image Sequences	Multiple image sequences can be loaded and simultaneously replayed. Timing of image sequences can be adjusted to create a common time reference. Time based synchronization allows images captured at different frame rates to be synchronized.
High Dynamic Range Mode	Making use of the full sensor dynamic range, HDR mode allows enhanced detail in both light and dark areas of an image to be displayed simultaneously.
Motion Detector	In order to highlight subtle changes in an image, Motion Detector allows a reference image to be subtracted from a recorded sequence. Details including propagation of shock waves and surface changes during impact can be visualized using the feature.
Line Profile	A line profile representing grey levels along a line drawn across any region of the image is displayed. In live mode the Line Profile can be used to ensure optimum image focus is achieved.
Histogram	A histogram displaying grey levels within a user-defined image area is displayed. In live mode the Histogram can be used to ensure that optimum exposure levels are set for the scene being recorded.

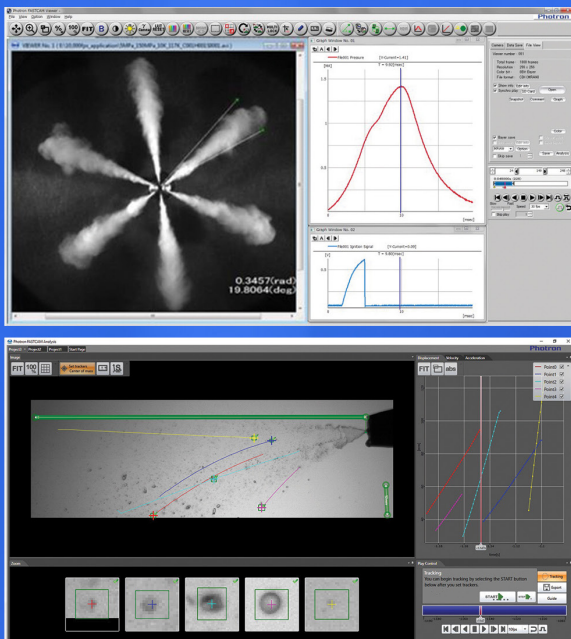

Photron FASTCAM Viewer:

Photron FASTCAM Viewer software (PFV) has been designed to provide an intuitive and feature rich user interface for the control of Photron high-speed cameras, data saving, image replay and simple motion analysis. Advanced operation menus provide access to features for advanced camera operation and image enhancement. Tools are provided to allow image calibration and easy measurement of angles and distances from image data. Also included are a C++ SDK and wrappers for LabView and MATLAB ®.

An optional software plug-in module provides synchronisation between Photron high-speed cameras and data acquired through National Instruments data acquisition systems. Synchronised data captured by the DAQ system provides waveform information which can be viewed alongside high-speed camera images.

Photron FASTCAM Analysis:

PFV software allows image sequences to be exported directly to optional Photron FASTCAM Analysis (PFA) Motion Analysis software. This entry level Motion Analysis software with an on screen 'step by step guide' function launches automatically from Photron FASTCAM Viewer software, and provides automated tracking of up to 5 points using feature or correlation tracking algorithms for the automated analysis of motion within an image sequence.

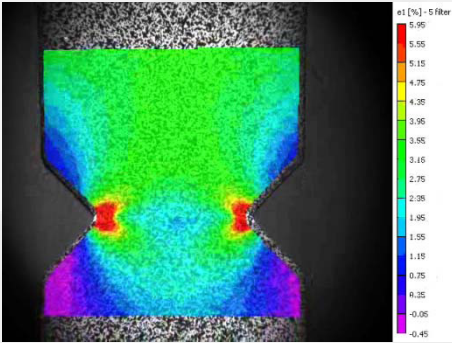

Material Testing & DIC



Biomechanics

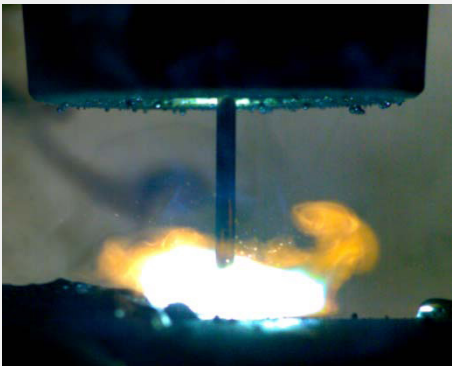

Welding & Plasma Research

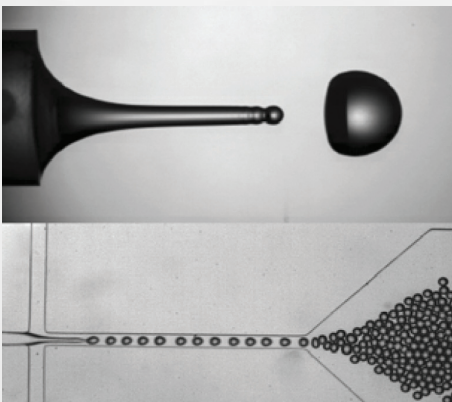

Fluid Dynamics & Microfluidics

Mini UX100							
Resolution	Frame Rate	8GB		16GB		32GB	
(h x v pixels)	Max fps	Frames	Time (sec)**	Frames	Time (sec)**	Frames	Time (sec)**
1280 x 1024	4,000	4,365	1.09	8,734	2.18	17,472	4.37
1280 x 800	6,250	5,587	0.89	11,179	1.79	22,364	3.58
1280 x 720	6,400	6,208	0.97	12,421	1.94	24,849	3.88
1280 x 512	8,192	8,734	1.07	17,468	2.13	34,944	4.27
1280 x 120	40,960	37,248	0.91	74,531	1.82	149,096	3.64
1024 x 1024	4,000	5,458	1.36	10,917	2.73	21,840	5.46
896 x 896	5,120	7,129	1.39	14,259	2.78	28,526	5.57
1280 x 24	204,800	186,242	0.91	372,656	1.82	745,483	3.64

Mini UX50							
Resolution	Frame Rate	8GB		16GB		32GB	
(h x v pixels)	Max fps	Frames	Time (sec)**	Frames	Time (sec)**	Frames	Time (sec)**
1280 x 1024	2,000	4,365	2.18	8,734	4.37	17,472	8.74
1280 x 800	2,500	5,587	2.23	11,179	4.47	22,364	8.95
1280 x 720	3,200	6,208	1.94	12,421	3.88	24,849	7.77
1280 x 512	4,000	8,734	2.18	17,468	4.37	34,944	8.74
1280 x 120	20,480	37,248	1.82	74,531	3.64	149,096	7.28
1024 x 1024	2,000	5,458	2.73	10,917	5.46	21,840	10.92
896 x 896	2,500	7,129	2.85	14,259	5.70	28,526	11.41
1280 x 24	102,400	186,242	1.82	372,656	3.64	745,483	7.28

* Specifications subject to change without notice.

** Recording time is an estimate and may be different depending on recording conditions and settings.

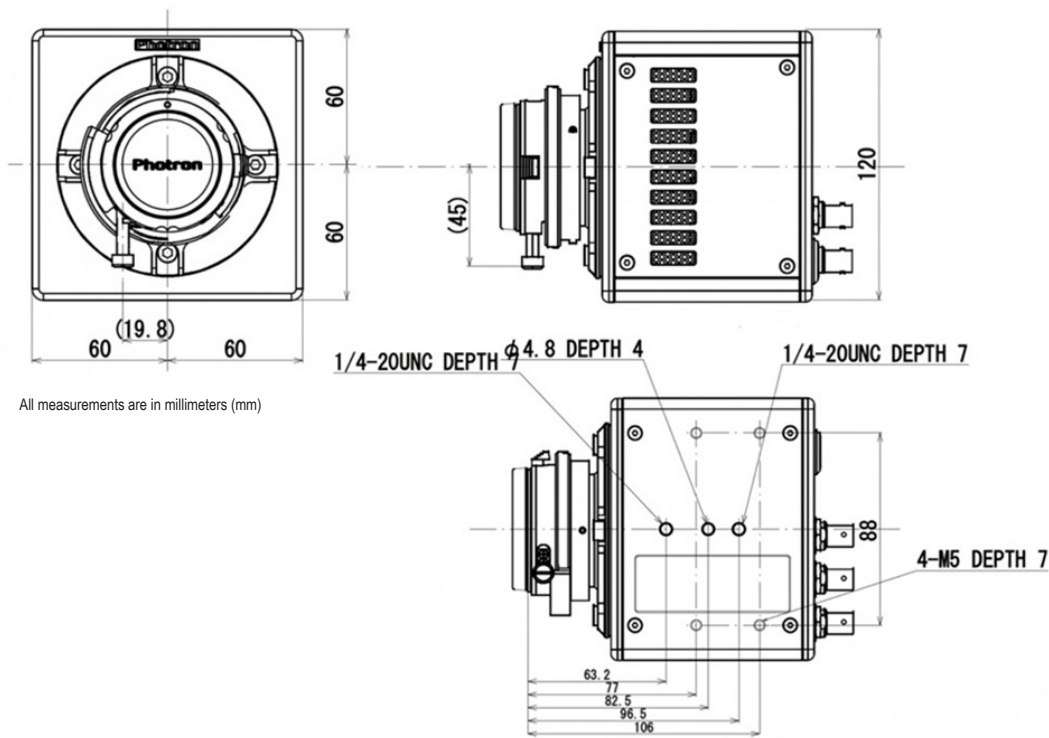

All measurements are in millimeters (mm)

Compatibility with Specialist Lens Systems:

A combination of small physical size, low weight and high light sensitivity allows the FASTCAM Mini UX to be coupled to a range of optical systems such as scientific and long distance microscopes, rigid endoscopes or borescopes and image intensifiers for applications ranging from imaging flows in microfluidic devices to combustion diagnostics.

Rugged and Compact Design:

The FASTCAM Mini UX is engineered for use in environments where it may be subject to extreme mechanical shock and vibration. The system has been fully tested for repeated operation at 100G, 10ms, 6-axes.

Small Physical Size:

The small physical size and weight of the Mini camera range allows the use of conventional opto-mechanical hardware for rigid and stable mounting of multiple cameras, and for the location of cameras in space limited locations.

Specifications subject to change without notice.

Mechanical and Environmental Specifications

Mechanical

Lens Mount	F-mount (G-type lens compatible) and C-mount provided
Camera Mountings	4 x 1/4 - 20 UNC (base and top), 4 x M5 (base)

External Dimensions

Camera Body	120mm (H) x 120mm (W) x 93mm (D)
(excluding protrusions)	4.72" (H) x 4.72" (W) x 3.66" (D)

Weight

Camera Body	1.5kg (3.31lbs)
-------------	-----------------

Environmental

Operating Temperature	0 to 40C, 32° to 104°F
Storage Temperature	-20 to 60C, -4° to 140°F
Humidity	85% or less (non condensing)
Cooling	Internal fan cooling (fan-off mode supported)
Operational Shock	100G, 10ms, 6-axes

Power

AC Power (with supplied adapter)	100 to 240V, 50 to 60Hz
DC Power	22 to 32V, 40VA

PHOTRON USA, INC.
9520 Padgett Street, Suite 110
San Diego, CA 92126
USA

Tel: 858.684.3555 or 800.585.2129
Fax: 858.684.3558
Email: image@photron.com
www.photron.com

PHOTRON EUROPE LIMITED
The Barn, Bottom Road
West Wycombe
Bucks. HP14 4BS
United Kingdom

Tel: +44 (0) 1494 481011
Fax: +44 (0) 1494 487011
Email: image@photron.com
www.photron.com

PHOTRON (Shanghai)
Room 20C, Zhao-Feng
World Trade Building
No. 369, JiangSu Road
Chang Ning District
Shanghai, 200050 China
Tel: +86 (21) 5268-3700
Fax: +86 (21) 5268-3702
Email: info@photron.cn.com
www.photron.cn.com

PHOTRON LIMITED
21F, Jinbocho Mitsui Bldg.
1-105 Kanda Jimbocho
Chiyoda-ku, Tokyo 101-0051
Japan

Tel: +81 (3) 3518-6271
Fax: +81 (3) 3 3518-6279
Email: image@photron.co.jp
www.photron.co.jp